

Touchpad Controls for Half-fill Full-fill Stainless Steel Bath Backplates (BFP-HF-FF)

These touchpads fit into the steel bath filling plate (BFP)

Touchpad Switches

Require a small push to make the contact

Order Code: **BFPTP**



Pre-wired with 3m cable as standard

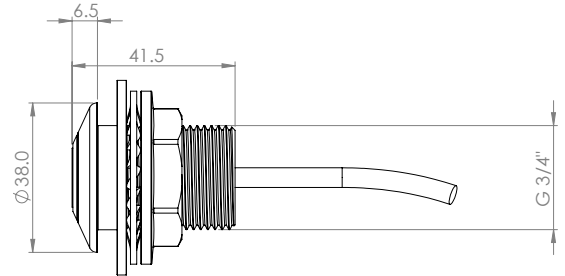
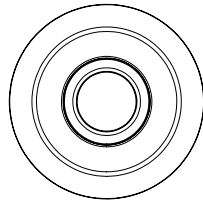

Mains Powered Kits

BFP-HF-FF half-fill full-fill steel bath filling plate – Controls for 15mm pipe

TPTS-M/HP/BFP-HF-FF Touchpad kit

Each kit c/w: 1 × control box with integral 12v PSU, 1 × 15mm HP 12v solenoid valve, 2 × pre-wired touchpads.

BFP-HF-FF half-fill full-fill steel bath filling plate – Controls for 22mm pipework

TPTS-M/HP^{3/4}"/BFP-HF-FF Touchpad kit

Each kit c/w: 1 × control box with integral 12v PSU, 1 × ^{3/4}" BSP HP 12v solenoid valve, 2 × pre-wired touchpads.

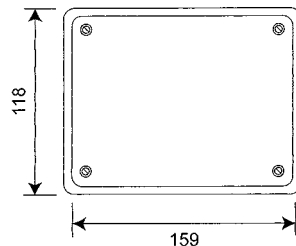
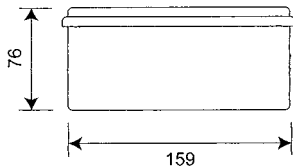

Standard bath control box with adjustable valve open time from 1 minute to 10 minutes.



Standard 15mm High Pressure (HP) 12v solenoid valves 0.5 bar – 6 bar

For mains powered kits Standard high pressure (HP)

12v nylon pre-wired 15mm solenoid valve for mains powered kits.

Working Temperature Range 0°C to 60°C
Electrical connection: Spade connectors / 2-core Ø0.5mm copper cable

TECHNICAL DATA

Gross weight	0.215 kg
Material	Nylon
Seal Material	NBR (Nitrile)
Voltage	12vDC
Power	3W
Connection	15mm Compression
Pressure rating	0.5 Bar – 6 Bar
Operation type	Normally closed
Cable length	3m

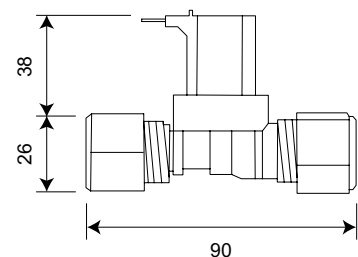

Optional ^{3/4}" BSP High Pressure (HP) 12v solenoid valves 0.5 bar – 8 bar

For mains powered kits Optional high pressure (HP^{3/4}"

12v (19mm orifice) solenoid valve for mains powered kits.

You will need to provide length of 2 core cable from valve to control box.

TECHNICAL DATA

Material	ABS/Brass
O-ring/washers	Nitrile
Pressure rating	0.5 Bar – 8 Bar max.
Orifice	19mm
Connection	^{3/4} " BSP
Voltage	12vDC
Operation type	Normally closed

LOW PRESSURE OPTION (LP)

WRAS approved low pressure (LP) ^{3/4}" BSP valve for water pressure 0 bar – 1 bar available on request

Battery Powered Kits

BFP-HF-FF half-fill full-fill steel bath filling plate – Controls for 15mm pipe

TPTS-B/HP/BFP-HF-FF Touchpad kit

Each kit c/w: 1 × control box & battery pack, 1 × 15mm HP 6v solenoid valve, 2 × pre-wired touchpads.

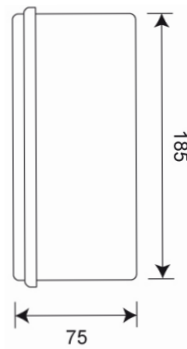
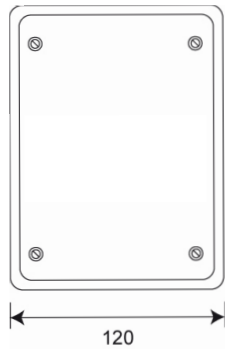

Standard bath control box with adjustable valve open time from 1 minute to 10 minutes.

BFP-HF-FF half-fill full-fill steel bath filling plate – Controls for 22mm pipework

TPTS-B/3/4"/BFP-HF-FF Touchpad kit

Each kit c/w: 1 × control box & battery pack, 1 × 3/4" BSP 6v solenoid valve, 2 × pre-wired touchpads.



Standard 15mm High Pressure (HP) 6v solenoid valves 0.75 bar – 10 bar

For battery powered kits Standard high pressure (HP)

6v non-wired G202 solenoid valve for battery powered kits. You will need to provide length of 2 core cable from valve to control box.

TECHNICAL DATA

Material ABS/Brass
O-ring/washers..... Nitrile material
Fitting 15mm Compression
Pressure rating 0.75 Bar – 10 Bar

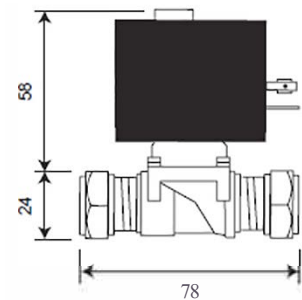

Optional 3/4" BSP 6v solenoid valves 0 bar – 6 bar

For battery powered kits Optional low pressure (LP3/4") 0 Bar – 6 Bar

6v (19mm orifice) solenoid valve for battery powered kits.

You will need to provide length of 2 core cable from valve to control box

TECHNICAL DATA

Material ABS/Brass
O-ring/washers..... Nitrile
Pressure rating 0 Bar – 6 Bar
Orifice 19mm
Connection 3/4" BSP
Voltage 6vDC
Operation type Latching



ROBERT PEARSON & COMPANY LTD

Post Office House, Post Office Lane
Stockton, Warminster
Wiltshire BA12 0SE

Telephone: (01985) 850954
Facsimile: (01985) 850112

E-Mail: sales@robertpearson.co.uk
Website: www.robertpearson.co.uk