

SHOWER AND BATH SENSOR CONTROLS

"No touch" hygienic sensor operation

Simply put your hand within 50mm of the sensor to turn water on. Turns water off automatically after use

You can choose your own shower or bath spout or one of ours. Sensor is fitted remotely.

Waterproof TPTS Model Brushed Stainless Steel Bath and Shower Sensor Kits

Waterproof brushed stainless steel bath/shower sensor c/w 8 metre cable



Mains-powered

water pressure 0.5 Bar – 6 Bar

Shower Order Codes:

TPTS-M/HP/1 Shower Sensor kit

- 1 no. Mains-powered shower control box
- 1 no. 15mm Plastic 12V solenoid valve
- 1 no. Waterproof sensor c/w 50mm steel bezel

TPTS-M/HP/2 Shower Sensor kit

- 1 no. Mains-powered shower control box
- 2 no. 15mm Plastic 12V solenoid valve
- 2 no. Waterproof sensor c/w 50mm steel bezel

Mains-powered

water pressure 0.5 Bar – 6 Bar

Bath Order Code:

TPTS-M/HP/1 Bath Sensor kit

- 1 no. Mains-powered bath control box
- 1 no. 15mm Plastic 12V solenoid valve
- 1 no. Waterproof sensor c/w 50mm steel bezel

Mains-powered

water pressure 0.5 Bar – 6 Bar

Bath Order Code:

TPTS-M/HP/1 Bath Sensor kit

- 1 no. Mains-powered bath control box
- 1 no. 15mm Plastic 12V solenoid valve
- 1 no. Waterproof sensor c/w 50mm steel bezel

Battery-powered

water pressure 0.75 Bar – 10 Bar

Shower Order Codes:

TPTS-B/HP/1 Shower Sensor kit

- 1 no. Battery-powered shower control box
- 1 no. 15mm G202 6V solenoid valve
- 1 no. Waterproof sensor c/w 50mm steel bezel

TPTS-B/HP/2 Shower Sensor kit

- 1 no. Battery-powered shower control box
- 2 no. 15mm G202 6V solenoid valve
- 2 no. Waterproof sensor c/w 50mm steel bezel

Battery-powered

water pressure 0.75 Bar – 10 Bar

Bath Order Code:

TPTS-B/HP/1 Bath Sensor kit

- 1 no. Battery-powered bath control box
- 1 no. 15mm G202 6V solenoid valve
- 1 no. Waterproof sensor c/w 50mm steel bezel



Brushed Stainless Steel AV Bath Sensor Kits

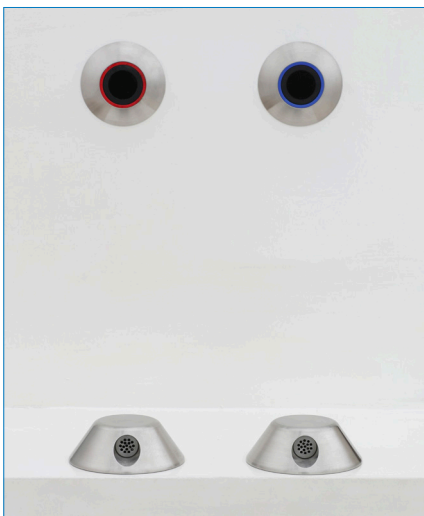

For applications that require separate hot and cold supplies per bath please use our colour coded anti-vandal Sensors. Steel thread sensor—ideal for custodial and mental health applications.

Mains-powered

water pressure 0.5 Bar – 6 Bar

Order Codes:

TPTS-M/HP/1 Bath AV Sensor Kit

- 1 no. Mains-powered bath control box
- 1 no. 15mm Plastic 12V solenoid valve
- 1 no. Steel AV Sensor (specify colour)

TPTS-M/HP/2 Bath AV Sensor Kit

- 1 no. Mains-powered tap control box
- 2 no. 15mm Plastic 12V solenoid valve
- 1 no. Stainless Steel AV Sensor (c/w red indicator) to denote hot water
- 1 no. Stainless Steel AV Sensor (c/w blue indicator) to denote cold water

Battery-powered

water pressure 0.75 Bar – 10 Bar

Order Codes:

TPTS-B/HP/1 Bath AV Sensor Kit

- 1 no. Battery-powered tap control box
- 1 no. 15mm G202 6V solenoid valve
- 1 no. Steel AV Sensor (specify colour)

TPTS-B/HP/2 Bath AV Sensor Kit

- 1 no. Battery-powered tap control box
- 2 no. 15mm G202 6V solenoid valve
- 1 no. Stainless Steel AV Sensor (c/w red indicator) to denote hot water
- 1 no. Stainless Steel AV Sensor (c/w blue indicator) to denote cold water

You can use our TPTS model AV bath sensor kits to control your own spouts or choose our spouts (pictured above with our ALN-DM ligature resistant deck-mounted brushed steel bath spouts from our vandal resistant and/or anti-ligature spouts and showerheads).

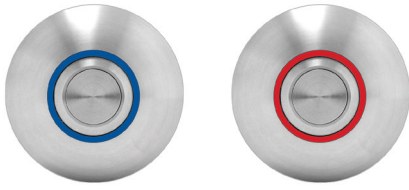

Blue for cold water Red for hot water

Mains Powered (0.5 Bar - 6 Bar)

TPTS-M/HP/1 Bath Touchpad kit

- 1 no. Mains-powered bath control box
- 1 no. 15mm Plastic 12V solenoid valve
- 1 no. Touchpad switch (specify colour)

TPTS-M/HP/2 Bath Touchpad kit

- 1 no. Mains-powered bath control box
- 2 no. 15mm Plastic 12V solenoid valve
- 2 no. Touchpad switch: 1 red, 1 blue

Battery Powered (0.75 Bar - 10 Bar)

TPTS-B/HP/1 Bath Touchpad kit

- 1 no. Battery-powered bath control box
- 1 no. 15mm G202 6V solenoid valve
- 1 no. Touchpad switch (specify colour)

TPTS-B/HP/2 Bath Touchpad kit

- 1 no. Battery-powered bath control box
- 2 no. 15mm G202 6V solenoid valve
- 2 no. Touchpad switch: 1 red, 1 blue

SHOWER & BATH SENSOR CONTROLS—TECHNICAL

Control Box

You can also set the system so you can activate the sensor once to turn the water on and then activate the sensor again to override the pre-set time and turn the water off immediately. It is possible to use 1 No. sensor to control 2 No. solenoid valves using a single control box.

Mains Shower Control Box: with adjustable valve open time from 30 seconds to 3 minutes. **You need to provide a 3 amp fused spur.** **Optional Purge Facility** available on mains shower kits. "Purge Facility" allows you to set the valve to open automatically if it has not been normally operated for more than a 24 hour period (to help prevent dead legs). **Optional Lock-Out Facility** available on mains shower kits. "Lock-Out Facility" ensures it will stop working if it has been operated more than 4 times in 15 minutes (will automatically re-set itself after 15 minutes).

Mains Bath Control Box: with adjustable valve open time from 1 minute to 10 minutes. **You need to provide a 3 amp fused spur.**

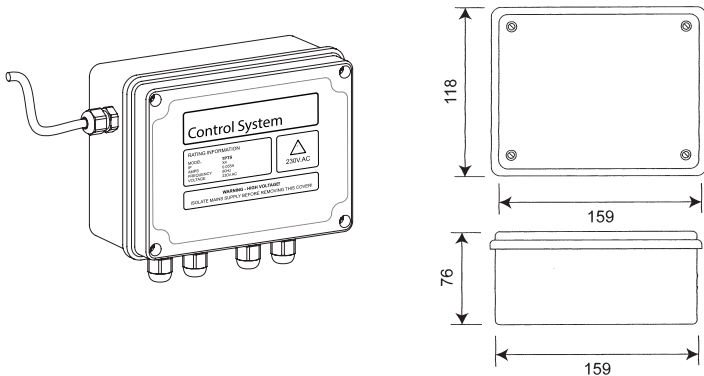

Battery Shower Control Box: with adjustable valve open time from 30 seconds to 3 minutes. **Optional Purge Facility** available on battery shower kits.

Battery Bath Control Box: with adjustable valve open time from 1 minute to 10 minutes.

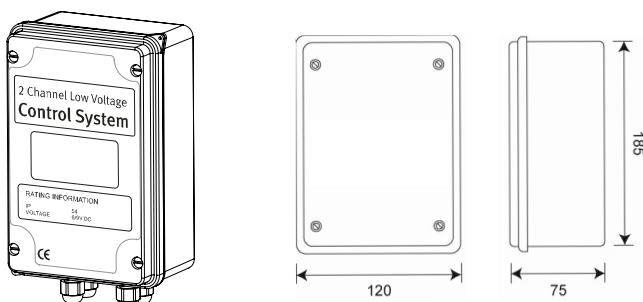

Sensor / Touchpad

Anti-Ligature & Vandal Resistant:
Ideal for custodial/mental health/
public & commercial applications.

Waterproof 50mm Sensor

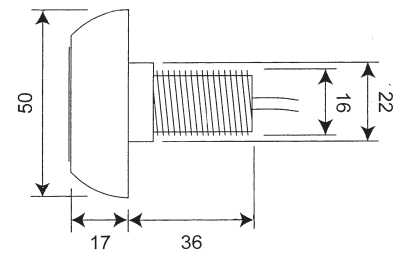

- Bezel diameter Ø50mm
- Overall length 53mm
- Thread length 36mm
- Thread material ABS Plastic
- Pre-wired YES
- Cable length 8m standard
- Finish Brushed steel

AV Sensor / Touchpad Switch

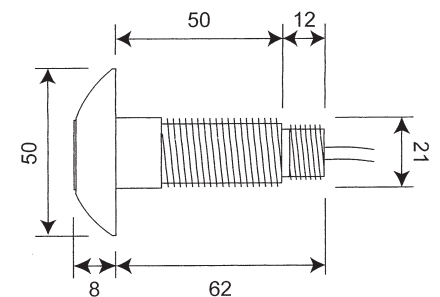

- Bezel diameter Ø50mm
- Overall length 70mm
- Thread length 50mm
- Thread material Stainless Steel
- Pre-wired YES
- Cable length 3m standard
- Finish Brushed Steel
- Insert colour Plain
Red (denotes hot)
Blue (denotes cold)

WRAS approved Solenoid Valves for Shower Controls

Please specify correct solenoid valves for your site conditions: for low pressure solenoid valves replace “HP” with “LP” in order codes. Very low pressure solenoid valves are only available for battery powered kits. Replace “HP” with “VLP” in order codes. Be aware that the narrower the orifice of the valve the lower the volume of water at the showerhead. You may want to consider using one of our 3/4" BSP 19mm orifice valves (see *Solenoid Valves for Bath Controls*).

For mains powered kits Standard high pressure (HP) 0.5 Bar – 6 Bar

12v nylon pre-wired 15mm solenoid valve for mains powered kits.

Working Temperature Range 0°C to 60°C
Electrical connection: Spade connectors / 2-core Ø0.5mm copper cable

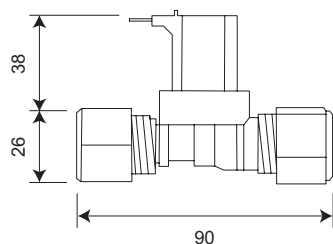

ORDER CODE
15mm 12v Plastic HP Valve

TECHNICAL DATA

Gross weight 0.215 kg
Material Nylon
Seal Material NBR (Nitrile)
Voltage 12vDC
Power 3W
Connection 15mm compression
Pressure rating 0.5 Bar – 6 Bar
Operation type Normally closed
Cable length 3m

For mains powered kits Optional low pressure (LP) 0 Bar – 0.5 Bar maximum

12v (7.1mm orifice) solenoid valve for mains powered kits.

You will need to provide length of 2 core cable from valve to control box.

ORDER CODE
15mm 12v (7.1mm) Valve

TECHNICAL DATA

Material ABS/Brass
O-ring/washers..... Nitrile
Pressure rating 0 Bar – 0.5 Bar max.
Orifice 7.1mm
Connection 15mm compression
Voltage 12vDC
Operation type Normally closed

For battery powered kits Standard high pressure (HP) 0.75 Bar – 10 Bar

6v non-wired G202 solenoid valve for battery powered kits.

You will need to provide length of 2 core cable from valve to control box.

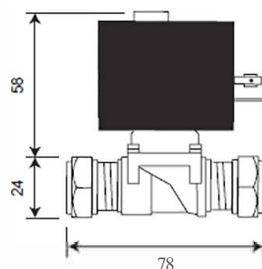

ORDER CODE
15mm 6v G202 Valve

TECHNICAL DATA

Material ABS/Brass
O-ring/washers..... Nitrile
Pressure rating 0.75 Bar – 10 Bar
Orifice 12.7mm
Connection 15mm compression
Voltage 6vDC
Operation type Latching

For battery powered kits Optional low pressure (LP) 0 Bar – 1.5 Bar maximum

6v (4mm orifice) solenoid valve for battery powered kits.

You will need to provide length of 2 core cable from valve to control box.

ORDER CODE
15mm 6v (4mm) Valve

TECHNICAL DATA

Material ABS/Brass
O-ring/washers..... Nitrile
Pressure rating 0 Bar – 1.5 Bar max.
Orifice 4mm
Connection 15mm compression
Voltage 6vDC
Operation type Latching

For battery powered kits Optional very low pressure (VLP) 0 Bar – 0.5 Bar maximum

6v (6.7mm orifice) solenoid valve for battery powered kits.

You will need to provide length of 2 core cable from valve to control box.

ORDER CODE
15mm 6v (6.7mm) Valve

TECHNICAL DATA

Material ABS/Brass
O-ring/washers..... Nitrile
Pressure rating 0 Bar – 0.5 Bar max.
Orifice 6.7mm
Connection 15mm compression
Voltage 6vDC
Operation type Latching



WRAS approved Solenoid Valves for Bath Controls

Please specify correct solenoid valves for your pipe diameter: For Ø22mm copper pipe, replace HP with HP¾" or LP with LP¾" in bath order codes.

For mains powered kits Standard high pressure (HP) 0.5 Bar – 6 Bar

12v nylon pre-wired 15mm solenoid valve for mains powered kits.

Working Temperature Range 0°C to 60°C
Electrical connection: Spade connectors / 2-core Ø0.5mm copper cable

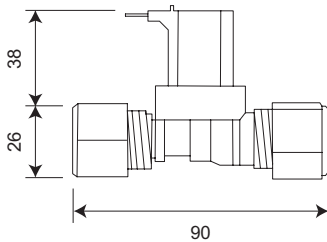

ORDER CODE
15mm 12v Plastic HP Valve

TECHNICAL DATA

Gross weight 0.215 kg
Material Nylon
Seal Material NBR (Nitrile)
Voltage 12vDC
Power 3W
Connection 15mm compression
Pressure rating 0.5 Bar – 6 Bar
Operation type Normally closed
Cable length 3m

For mains powered kits Optional high pressure (HP¾") 0.5 Bar – 8 Bar

12v (19mm orifice) solenoid valve for mains powered kits.

You will need to provide length of 2 core cable from valve to control box.

ORDER CODE
¾" 12v Valve (TPTS-M)

TECHNICAL DATA

Material ABS/Brass
O-ring/washers Nitrile
Pressure rating 0.5 Bar – 8 Bar max.
Orifice 19mm
Connection ¾" BSP
Voltage 12vDC
Operation type Normally closed

For battery powered kits Standard high pressure (HP) 0.75 Bar – 10 Bar

6v non-wired G202 solenoid valve for battery powered kits.

You will need to provide length of 2 core cable from valve to control box.

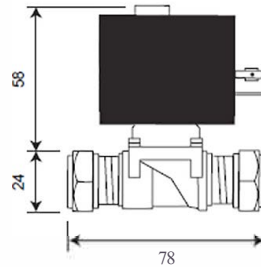

ORDER CODE
15mm 6v G202 Valve

TECHNICAL DATA

Material ABS/Brass
O-ring/washers Nitrile
Pressure rating 0.75 Bar – 10 Bar
Orifice 12.7mm
Connection 15mm compression
Voltage 6vDC
Operation type Latching

For battery powered kits Optional low pressure (LP¾") 0 Bar – 6 Bar

6v (19mm orifice) solenoid valve for battery powered kits.

You will need to provide length of 2 core cable from valve to control box.

ORDER CODE
¾" 6v Valve (TPTS-B)

TECHNICAL DATA

Material ABS/Brass
O-ring/washers Nitrile
Pressure rating 0 Bar – 6 Bar
Orifice 19mm
Connection ¾" BSP
Voltage 6vDC
Operation type Latching



ROBERT PEARSON & COMPANY LTD

Post Office House, Post Office Lane
Stockton, Warminster
Wiltshire BA12 0SE

Telephone: (01985) 850954
Facsimile: (01985) 850112

E-Mail: sales@robertpearson.co.uk
Website: www.robertpearson.co.uk